

SUNDRIES

SPIRAL CABLE WITH CONNECTORS

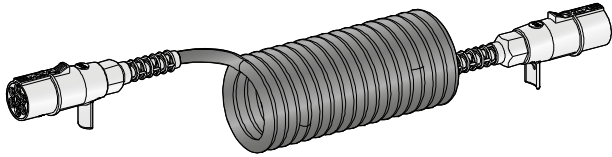

1



2



3

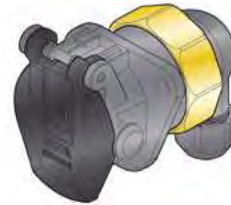

4

IMG	DESCRIPTION	PIN N.	SPIRAL COLOUR	MAX LENGTH mm	P/N BOX	M.O.Q.
1	SPIRAL CABLE VOLKSWAGEN	7	Black	4200	9815530	10
2	SPIRAL CABLE FORD	15-7	Red	5500	9815550	10
	SPIRAL CABLE VOLVO	15-7	Black	5500	9815560	10
3	SPIRAL CABLE	7	Black	4500	9815562	10
4	SOCKET FOR SPIRAL CABLE	15	-	-	2550087	50

SELF EXTINGUISHING CABLE TIES

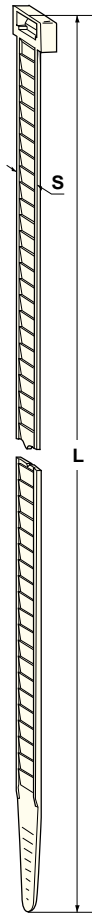

1

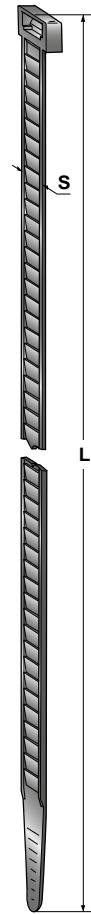

2

IMG.	DESCRIPTION	MATERIAL	OPERATION TEMP	L mm	S mm	Ø mm	Kg mm	P/N WHITE	M.O.Q.	P/N BLACK	M.O.Q.
1/2	SELF EXTINGUISHING CABLE TIE	PA66 V2 - UL94	-40°C +85°C	98	2,5	20	8			4621410	100
		PA66 V2 - UL94	-40°C +85°C	135	2,5	25	8			4621420	100
		PA66 V2 - UL94	-40°C +85°C	200	2,6	50	8			4621430	100
		PA66 V2 - UL94	-40°C +85°C	140	3,6	30	13			4621440	100
		PA66 V2 - UL94	-40°C +85°C	290	3,6	75	13	4621150	100	4621450	100
		PA66 V2 - UL94	-40°C +85°C	160	4,5	36	18			4621460	100
		PA66 V2 - UL94	-40°C +85°C	178	4,8	40	22			4621470	100
		PA66 V2 - UL94	-40°C +85°C	200	4,8	50	22	4621180	100	4621480	100
		PA66 V2 - UL94	-40°C +85°C	250	4,8	62	22			4621490	100
		PA66 V2 - UL94	-40°C +85°C	290	4,8	75	22	4621200	100	4621500	100
		PA66 V2 - UL94	-40°C +85°C	360	4,8	100	22	4621210	100	4621510	100
		PA66 V2 - UL94	-40°C +85°C	180	7,8	40	54			4621530	100
		PA66 V2 - UL94	-40°C +85°C	240	7,8	50	54			4621540	100
		PA66 V2 - UL94	-40°C +85°C	300	7,8	77	54			4621550	100
		PA66 V2 - UL94	-40°C +85°C	365	7,8	100	54	4621260	100	4621560	100
		PA66 V2 - UL94	-40°C +85°C	450	7,8	125	54			4621570	100
		PA66 V2 - UL94	-40°C +85°C	540	7,8	150	54			4621580	100
		PA66 V2 - UL94	-40°C +85°C	750	7,8	200	54			4621590	100

CABLE CLIPS

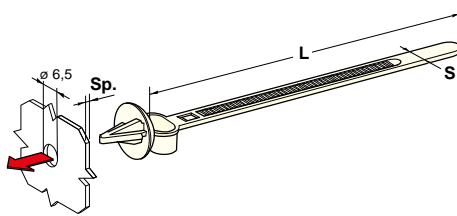

1

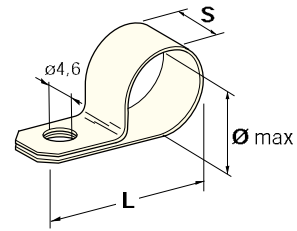

2

IMG	DESCRIPTION	MATERIAL	L mm	S mm	Ø mm	Sp mm		P/N BOX	M.O.Q.
1	REUSABLE TIE	PA66 V2 - UL94	140	6,5	6÷35	0,6÷2		4621051	200
	REUSABLE TIE	PA66 V2 - UL94	100	6	2÷16	0,6÷1,5		4621052	200
2	FIXING TUBE CLAMP	PA66	19,8	9,6	4,8	-		4612110	100
	FIXING TUBE CLAMP	PA66	22	10	6,35	-		4612120	100
	FIXING TUBE CLAMP	PA66	22	10	7,9	-		4612130	100
	FIXING TUBE CLAMP	PA66	24	12	9,5	-		4612140	100
	FIXING TUBE CLAMP	PA66	31	12	12,7	-		4612150	100
	FIXING TUBE CLAMP	PA66	34,3	12	15,8	-		4612160	100
	FIXING TUBE CLAMP	PA66	35	12	19,4	-		4612170	100
	FIXING TUBE CLAMP	PA66	43	12	25,4	-		4612180	100

PRESS SWITCHES

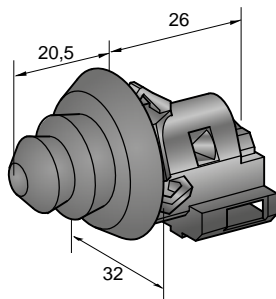

1

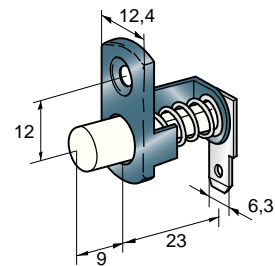

2

IMG	DESCRIPTION	APPLICATION	P/N BOX	M.O.Q.
1	PRESS SWITCH	MULTIFUNCTIONAL - RENAULT	4209655	1
2	PRESS SWITCH	DOORS FIAT RITMO - PANDA - 131 - 132 - 128	4209500	1

PRESS SWITCHES

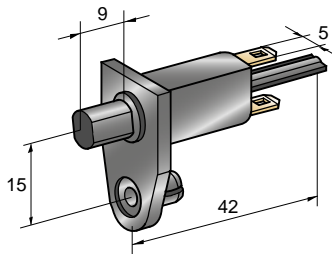

1

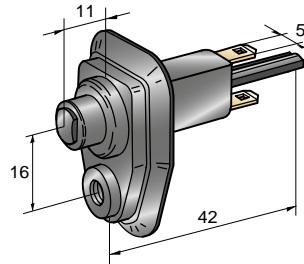

2

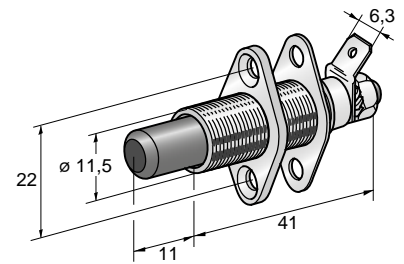

3

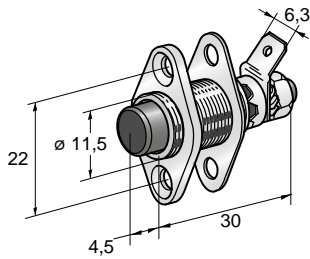

4

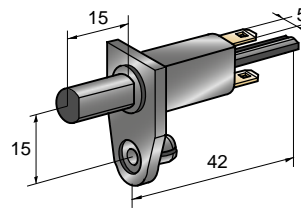

5

IMG	DESCRIPTION	APPLICATION	P/N BOX	M.O.Q.
1	PRESS SWITCH	DOORS FIAT UNO	4209520	1
2	PRESS SWITCH	DOORS FIAT CROMA - LANCIA THEMA	4209530	1
3	PRESS SWITCH	AUTOALARM, DOORS, TAILGATES	4209570	1
4	PRESS SWITCH	AUTOALARM, DOORS, TAILGATES	4209580	1
5	PRESS SWITCH	BOOT ALFA 164	4209590	1

RELAYS

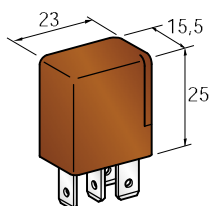

1

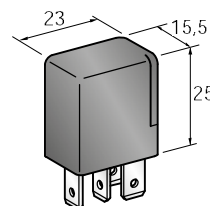

2

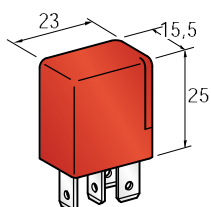

3

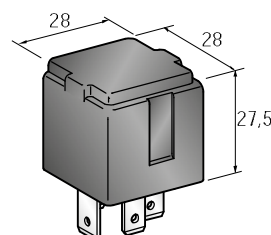

4

IMG	DESCRIPTION	COLOUR	RATED CURRENT WITH 80° C	RATED VOLTAGE	WORKING TEMPERATURE T.min/T.max	P/N BOX	M.O.Q.
1	MICRO RELAY	Brown	10A (NC) - 20A (NO)	12 V	-40°C +125°C	0603000	1
2	MICRO RELAY	Black	20A (NO)	12 V	-40°C +125°C	0603010	1
3	MICRO RELAY	Red	30A (NO)	12 V	-40°C +125°C	0603020	1
5	MAXI RELAY	Black	50A (NO)	12 V	-40°C +125°C	0603050	1

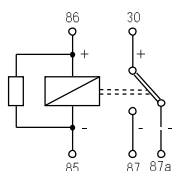

1

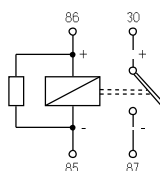

2

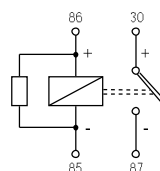

3

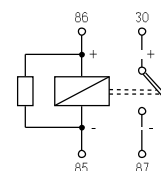

4

SELF EXTINGUISHING INSULATING TAPE

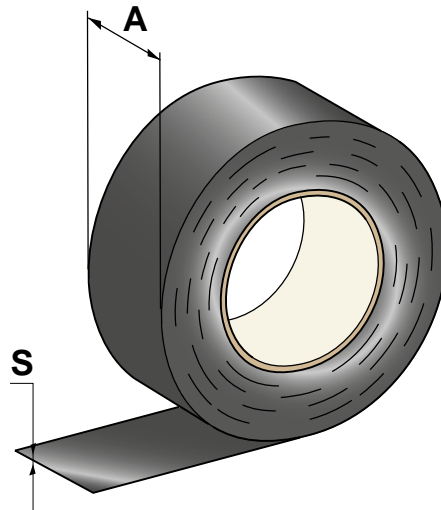

1

IMG	DESCRIPTION	MATERIAL	COLOUR	A mm	L mm	S mm	P/N BOX	M.O.Q.
1	SELF-EXTINGUISHING INSULATING TAPE	PVC - V0	■ Black	15	10000	0,15	4640100	10
	SELF-EXTINGUISHING INSULATING TAPE	PVC - V0	■ Black	15	25000	0,15	4640200	10
	SELF-EXTINGUISHING INSULATING TAPE	PVC - V0	■ Black	19	25000	0,15	4640300	10
	SELF-EXTINGUISHING INSULATING CLOTH TAPE	RAYON	■ Black	19	25000	0,28	0100302	96

LAMP HOLDERS

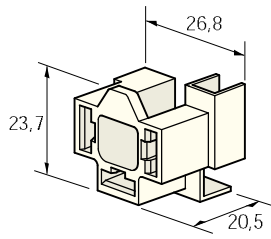

1

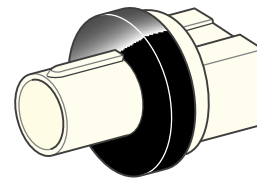

2

IMG	DESCRIPTION	MATERIAL	P/N BOX	M.O.Q.
1	3-WAY LAMP HOLDER	PA	4410510	50
2	PARKING LIGHTS AND DASHBOARD FOR LAMPS WITH W 2.1 X 9.5 D SOCKET		4008500	50

CONNECTIONS AND FIXINGS

IMG 1



FASTON F800
W/LOCK NOTCH

GROUND CONNECTIONS

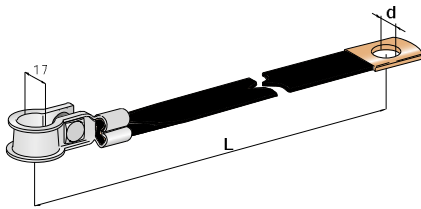

1

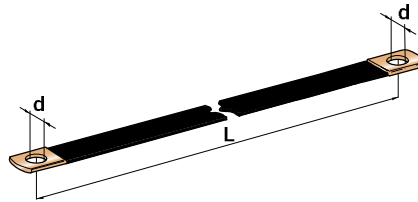

2

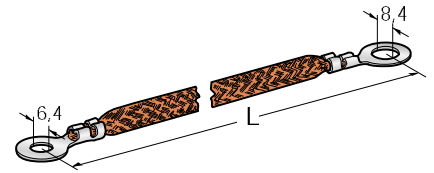

3

IMG	DESCRIPTION	WIRE SECTION mm ²	d mm	L mm		P/N BOX	M.O.Q.
1	EARTH CONNECTION	25	12,5	300		2508681	1
		25	12,5	400		2508682	1
		25	12,5	500		2508683	1
2	EARTH CONNECTION	10	8,4	210		2508650	1
		10	8,4	280		2508652	1
		15	10,4	330		2508660	1
		15	10,4	450		2508661	1
		15	10,4	280		2508662	1
		15	10,4	210		2508663	1
		25	12,5	320		2508670	1
		25	12,5	230		2508671	1
3	EARTH CONNECTION	25	12,5	400		2508672	1
		-	-	300		2508220	10



1

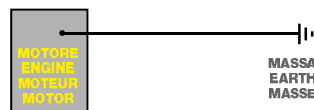

2



3