

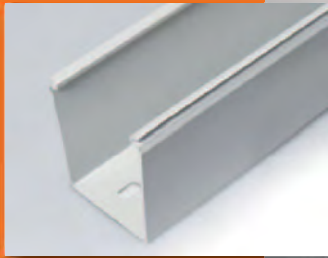

C2

Leitungskanäle ohne Seitenschlitze



Verdrahtungskanäle ohne Seitenschlitze



Die Verdrahtungskanäle:

Seite	Typ	Höhen in mm	Breiten in mm	Bodenstanzung	Eigenschaften
• C2/1	GN-S LF	30-40-60-80-100	25-40-60-80-100-120	ja	LF
	GN-HF-S	30-40-60-80	30-40-60	nein	HF LF
• C2/2	GF-DIN-SH-S	25-37,5-50-75	25-37,5-50-75-100-125	ja	HF LF

Die Zubehöre

- C3/1 PLIO Spreiznieten und Montagewerkzeug SES-GO
- Knopf PLIO-GZ
- Sockel PLIO-GZ
- Doppelseitiges Klebeband PLIOBANDE

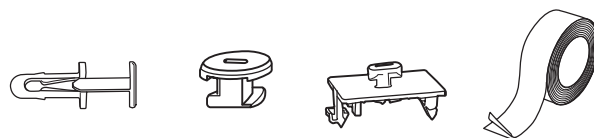

Leitungskanäle SES mit Bodenstanzung





GN-S LF



GN-S LF

Material:	Hart-PVC Qualität 9051 LF
Farbe:	grau RAL7030
Gebrauchstemperaturen:	-5 bis +65°C
Dichte:	1,56
Durchgangswiderstand:	10 ¹⁵ Ω.cm
Durchschlagfestigkeit:	15 kV/mm
Eigenschaften:	V0 UL94 DIN 5510-2 S3, SR1, ST2
Standard Länge:	2 Meter
Doppelseitiges Klebeband:	auf Anfrage
Mindestmenge:	1 komplette Verpackung (Inkl. Deckel)



Typ	Kanäle Art. Nr.	 m	Aussenmasse		Anzahl Kabel pro Kanal (Füllung 50 %)			Deckel (Einzel) Art. Nr.	 m	
			H mm	B mm	1 mm ²	1,5 mm ²	2,5 mm ²			
GN-S	30 x 25	0839 0031 013	60	30	25	37	31	26	0839 0500 013	48
GN-S	30 x 40	0839 0032 013	36	30	40	68	56	47	0839 0510 013	24
GN-S	40 x 25	0839 0041 013	48	40	25	52	43	36	0839 0500 013	48
GN-S	40 x 40	0839 0042 013	32	40	40	94	77	64	0839 0510 013	24
GN-S	40 x 60	0839 0043 013	24	40	60	149	122	102	0839 0520 013	24
GN-S	40 x 80	0839 0044 013	24	40	80	204	168	140	0839 0530 013	24
GN-S	40 x 100	0839 0045 013	12	40	100	259	213	178	0839 0540 013	12
GN-S	60 x 25	0839 0051 013	48	60	25	80	66	55	0839 0500 013	48
GN-S	60 x 40	0839 0052 013	32	60	40	144	118	99	0839 0510 013	24
GN-S	60 x 60	0839 0053 013	24	60	60	229	188	157	0839 0520 013	24
GN-S	60 x 80	0839 0054 013	16	60	80	313	257	215	0839 0530 013	24
GN-S	60 x 100	0839 0055 013	16	60	100	398	327	273	0839 0540 013	12
GN-S	60 x 120	0839 0056 013	12	60	120	483	397	332	0839 0550 013	12
GN-S	80 x 25	0839 0061 013	24	80	25	107	88	74	0839 0500 013	48
GN-S	80 x 40	0839 0062 013	24	80	40	193	159	133	0839 0510 013	24
GN-S	80 x 60	0839 0063 013	24	80	60	308	253	211	0839 0520 013	24
GN-S	80 x 80	0839 0064 013	16	80	80	422	347	290	0839 0530 013	24
GN-S	80 x 100	0839 0065 013	12	80	100	537	441	369	0839 0540 013	12
GN-S	80 x 120	0839 0066 013	16	80	120	652	535	447	0839 0550 013	12
GN-S	100 x 40	0839 0071 013	24	100	40	240	198	165	0839 0510 013	24
GN-S	100 x 60	0839 0072 013	16	100	60	384	316	264	0839 0520 013	24
GN-S	100 x 80	0839 0073 013	16	100	80	529	435	363	0839 0530 013	24
GN-S	100 x 100	0839 0074 013	16	100	100	673	553	462	0839 0540 013	12

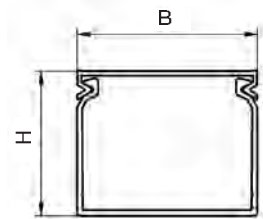

B = 25, 40 und 60 mm

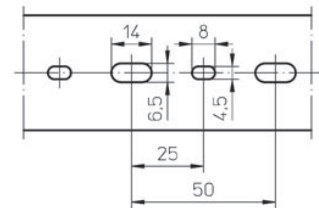

B = 80, 100 und 120 mm

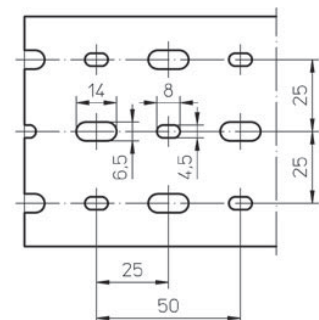

Bodenstanzung gemäss
NF EN 50085

Leitungskanäle SES mit Bodenstanzung





GN-HF-S

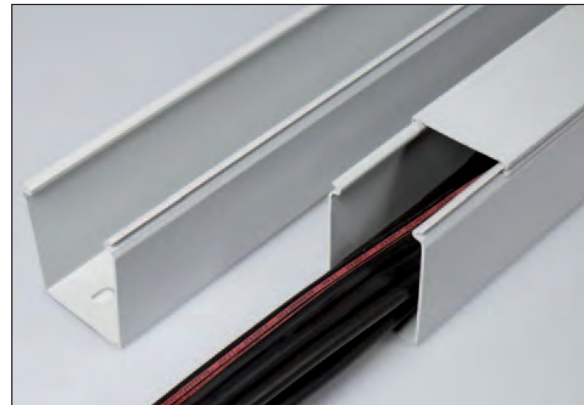

GN-HF-S

Material:	PC/ABS, halogenfrei
Farbe:	hell grau RAL7035
Gebrauchstemperaturen:	-25 bis +90°C
Durchgangswiderstand:	10 ¹⁵ Ω·cm
Durchschlagfestigkeit:	35 kV/mm
Eigenschaften:	V0 UL94 NF F 16-101/102 : I3/F2 DIN 5510-2 : S4-SR2-ST2 EN 45545-2 : R22 HL3, R23 HL3
Standard Länge:	2 Meter
Doppelseitiges Klebeband:	auf Anfrage
Mindestmenge:	1 komplette Verpackung (Inkl. Deckel)



Typ	Kanäle Art. Nr.	 m	Aussenmasse		Anzahl Kabel pro Kanal (Füllung 50 %)			Deckel (Einzel) Art. Nr.	 m
			H mm	B mm	1 mm ²	1,5 mm ²	2,5 mm ²		
GN-HF-S 30 x 30	0850 0033 025	48	30	30	48	39	33	0850 0505 025	24
GN-HF-S 40 x 40	0850 0042 025	32	40	40	94	77	64	0850 0510 025	24
GN-HF-S 40 x 60	0850 0043 025	24	40	60	149	122	102	0850 0510 025	24
GN-HF-S 60 x 40	0850 0052 025	32	60	40	144	118	99	0850 0520 025	24
GN-HF-S 80 x 40	0850 0062 025	24	80	40	193	159	133	0850 0520 025	24

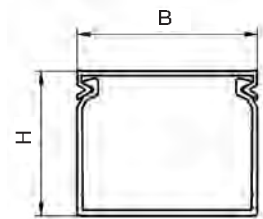

B 30, 40, 60

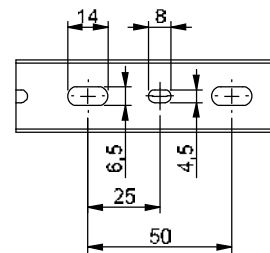

Bodenstanzung gemäss
NF EN 50085

Leitungskanäle SES mit Bodenstanzung





GF-DIN-SH-S



GF-DIN-SH-S

Material:	Polyphenylenether, modifiziert (PPE/PS)
Farbe:	hellgrau RAL7035
Gebrauchstemperaturen:	-25 bis +70°C
Durchgangswiderstand:	10 ¹⁵ Ω.cm
Durchschlagfestigkeit:	16 kV/mm
Eigenschaften:	V1 UL94
Standard Länge:	2 Meter
Doppelseitiges Klebeband:	auf Anfrage
Mindestmenge:	1 komplette Verpackung (Inkl. Deckel)



Typ	Kanäle Art. Nr.	 m	Ausssenasse		Anzahl Kabel pro Kanal (Füllung 50 %)			Deckel (Einzel) Art. Nr.	 m
			H mm	B mm	1 mm ²	1,5 mm ²	2,5 mm ²		
GF-DIN-SH-S 25 x 25	0848 0331 013	48	23,0	23,0	25	21	17	0848 0640 013	12
GF-DIN-SH-S 37,5x 25	0848 0341 013	48	35,5	23,0	44	36	30	0848 0640 013	12
GF-DIN-SH-S 37,5x 37,5	0848 0351 013	24	35,5	35,5	74	61	51	0848 0645 013	12
GF-DIN-SH-S 50 x 25	0848 0431 013	48	48,0	23,0	62	51	42	0848 0640 013	12
GF-DIN-SH-S 50 x 37,5	0848 0441 013	24	48,0	35,5	104	85	71	0848 0645 013	12
GF-DIN-SH-S 50 x 50	0848 0451 013	24	48,0	48,0	146	120	100	0848 0650 013	12
GF-DIN-SH-S 50 x 75	0848 0452 013	24	48,0	73,0	230	189	158	0848 0655 013	12
GF-DIN-SH-S 50 x100	0848 0453 013	12	48,0	98,0	315	259	216	0848 0660 013	12
GF-DIN-SH-S 75 x 25	0848 0511 013	48	73,0	23,0	101	83	69	0848 0640 013	12
GF-DIN-SH-S 75 x 37,5	0848 0521 013	24	73,0	35,5	161	132	111	0848 0645 013	12
GF-DIN-SH-S 75 x 50	0848 0531 013	24	73,0	48,0	227	186	156	0848 0650 013	12
GF-DIN-SH-S 75 x 75	0848 0541 013	24	73,0	73,0	358	294	246	0848 0655 013	12
GF-DIN-SH-S 75 x100	0848 0551 013	12	73,0	98,0	489	402	336	0848 0660 013	12
GF-DIN-SH-S 75 x125	0848 0561 013	12	73,0	123,0	620	509	426	0848 0665 013	12

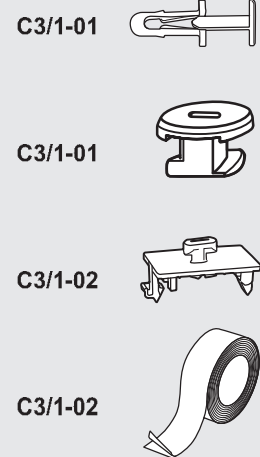
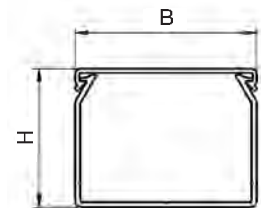

B = 25, 37,5 und 50 mm

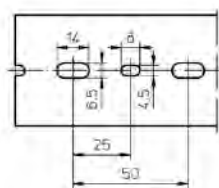

B = 75, 100 und 125 mm

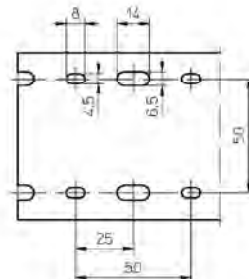

Bodenstanzung gemäss Norm DIN 43659