





















C1

Verdrahtungskanäle mit Seitenschlitzen



Verdrahtungskanal-Programm:

| Seite | Typ | Höhe in mm | Breite in mm | Eigenschaften |
|-----------|--|-----------------|----------------------------|---|
| • C1/1-01 | GN-A6/4 LF | 30-40-60-80-100 | 25-30-40-60-80-100-120-150 |   |
| • C1/1-03 | GN-HF-A6/4 | 30-40-60-80-100 | 25-30-40-60-80-100 |    |
| • C1/1-05 | GN-A6/4 blau | 30-40-60-80-100 | 25-30-40-60-80-100 |   |
| • C1/2-01 | GF-DIN-A7/5 | 23-35,5-48-73 | 23-35,5-48-73-98-123 |   |
| • C1/2-01 | GF-DIN-A6/4 | 100 | 48-73 |   |
| • C1/2-03 | GF-DIN-SH-A7/5 | 23-35,5-48-73 | 23-35,5-48-73-98-123 |    |
| • C1/2-05 | GF-DIN-C-A12/8 | 35,5-48-73 | 23-35,5-48-73-98-123 |   |
| • C1/3-01 | GF-A12/8 | 100 | 100-150 |   |
| • C1/5-01 | GF-DIN-PPDA | 48 | 48-73-98-123 | mit seitlicher Vorstanzung |
| • C1/5-03 | Verdrahtungskanäle mit speziell Seiten- oder Bodenstanzungen, speziell Längen. | | | |

Zubehör:

- C3/1 PLIO Spreiznieten und Montagewerkzeug SES-GO
Knopf PLIO-GZ
Sockel PLIO-GZ
Doppelseitiges Klebeband: PLIOBANDE

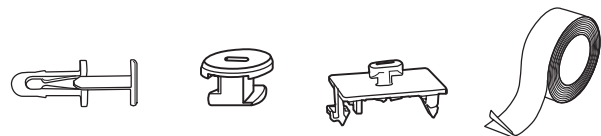

- C3/5 Rückhalteklämme PLIO-GX
Rückhalteklammer PLIO-GX
Rückhalteklammer BR-GN

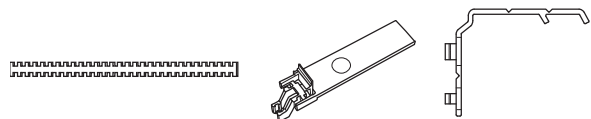

- C3/6 Etikettenträger PLIO



- C3/7 Verdrahtungskanalschneider DC 125

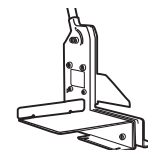

- D4/6-01 Lamellenschneidezange DK-55
Nutschere DK-60

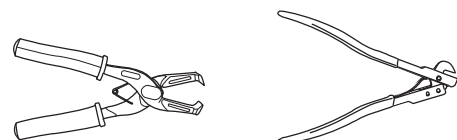

Verdrahtungskanäle SES mit senkrechter Seiten- und Bodenstanzung





GN-A6/4 LF



GN-A6/4 LF

| | |
|----------------------------------|--|
| Material: | Hart-PVC Qualität 9051 LF |
| Farbe: | grau RAL7030 |
| Gebrauchstemperaturen: | -5 bis +65°C |
| Dichte: | 1,56 |
| Durchgangswiderstand: | 10 ¹⁵ Ω.cm |
| Durchschlagfestigkeit: | 15kV/mm |
| Eigenschaften: | V0 UL94 DIN 5510-2 S3, SR1, ST2 |
| Standardlänge: | 2 Meter |
| Doppelseitiges Klebeband: | auf Anfrage |
| Mindestmenge: | 1 komplette Verpackung (inkl. Deckel) |



| Typ | Verdrahtungs- kanal Art. Nr. |  m | Ausßenmasse | | Anzahl Kabel pro Verdrahtungskanal (Füllung 50 %) | | | Deckel (Einzel) Art. Nr. |  m |
|---------|------------------------------------|--|-------------|---------|--|------------------------|------------------------|--------------------------------|--|
| | | | H mm | B mm | 1 mm ² | 1,5 mm ² | 2,5 mm ² | | |
| GN-A6/4 | 30 x 25 | 0839 0131 013 | 60 | 30 | 37 | 31 | 26 | 0839 0500 013 | 48 |
| GN-A6/4 | 30 x 40 | 0839 0132 013 | 36 | 30 | 68 | 56 | 47 | 0839 0510 013 | 24 |
| GN-A6/4 | 40 x 25 | 0839 0141 013 | 48 | 40 | 52 | 43 | 36 | 0839 0500 013 | 48 |
| GN-A6/4 | 40 x 30 | 0839 0146 013 | 36 | 40 | 66 | 54 | 45 | 0839 0505 013 | 24 |
| GN-A6/4 | 40 x 40 | 0839 0142 013 | 32 | 40 | 94 | 77 | 64 | 0839 0510 013 | 24 |
| GN-A6/4 | 40 x 60 | 0839 0143 013 | 24 | 40 | 149 | 122 | 102 | 0839 0520 013 | 24 |
| GN-A6/4 | 40 x 80 | 0839 0144 013 | 24 | 40 | 204 | 168 | 140 | 0839 0530 013 | 24 |
| GN-A6/4 | 40 x 100 | 0839 0145 013 | 12 | 40 | 259 | 213 | 178 | 0839 0540 013 | 12 |
| GN-A6/4 | 60 x 25 | 0839 0151 013 | 48 | 60 | 80 | 66 | 55 | 0839 0500 013 | 48 |
| GN-A6/4 | 60 x 30 | 0839 0157 013 | 40 | 60 | 102 | 83 | 70 | 0839 0505 013 | 24 |
| GN-A6/4 | 60 x 40 | 0839 0152 013 | 32 | 60 | 144 | 118 | 99 | 0839 0510 013 | 24 |
| GN-A6/4 | 60 x 60 | 0839 0153 013 | 24 | 60 | 229 | 188 | 157 | 0839 0520 013 | 24 |
| GN-A6/4 | 60 x 80 | 0839 0154 013 | 16 | 60 | 313 | 257 | 215 | 0839 0530 013 | 24 |
| GN-A6/4 | 60 x 100 | 0839 0155 013 | 16 | 60 | 398 | 327 | 273 | 0839 0540 013 | 12 |
| GN-A6/4 | 60 x 120 | 0839 0156 013 | 12 | 60 | 483 | 397 | 332 | 0839 0550 013 | 12 |
| GN-A6/4 | 80 x 25 | 0839 0161 013 | 24 | 80 | 107 | 88 | 74 | 0839 0500 013 | 48 |
| GN-A6/4 | 80 x 30 | 0839 0167 013 | 24 | 80 | 136 | 112 | 94 | 0839 0505 013 | 24 |
| GN-A6/4 | 80 x 40 | 0839 0162 013 | 24 | 80 | 193 | 159 | 133 | 0839 0510 013 | 24 |
| GN-A6/4 | 80 x 60 | 0839 0163 013 | 24 | 80 | 308 | 253 | 211 | 0839 0520 013 | 24 |
| GN-A6/4 | 80 x 80 | 0839 0164 013 | 16 | 80 | 422 | 347 | 290 | 0839 0530 013 | 24 |
| GN-A6/4 | 80 x 100 | 0839 0165 013 | 12 | 80 | 537 | 441 | 369 | 0839 0540 013 | 12 |
| GN-A6/4 | 80 x 120 | 0839 0166 013 | 16 | 80 | 652 | 535 | 447 | 0839 0550 013 | 12 |
| GN-A6/4 | 100 x 30 | 0839 0170 013 | 32 | 100 | 169 | 138 | 116 | 0839 0505 013 | 24 |
| GN-A6/4 | 100 x 40 | 0839 0171 013 | 24 | 100 | 240 | 198 | 165 | 0839 0510 013 | 24 |
| GN-A6/4 | 100 x 60 | 0839 0172 013 | 16 | 100 | 384 | 316 | 264 | 0839 0520 013 | 24 |
| GN-A6/4 | 100 x 80 | 0839 0173 013 | 16 | 100 | 529 | 435 | 363 | 0839 0530 013 | 24 |
| GN-A6/4 | 100 x 100 | 0839 0174 013 | 16 | 100 | 673 | 553 | 462 | 0839 0540 013 | 12 |
| GN-A6/4 | 100 x 150 | 0839 0175 013 | 8 | 100 | 1034 | 849 | 710 | 0839 0560 013 | 12 |

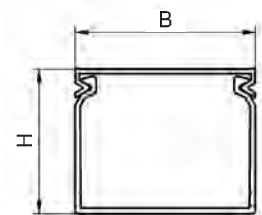

C3/1-01

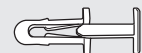

C3/1-01



C3/1-02

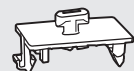

C3/1-02



C3/5-01



C3/5-02

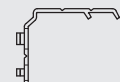

C3/6-01

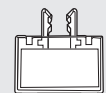

C3/6-01

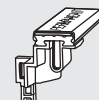

D4/6-01

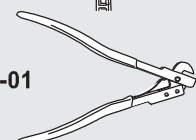

GN-A6/4 LF

H = 30 mm
H = 40 mm

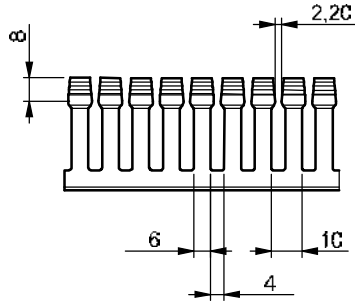

B 25, 30, 40, 60

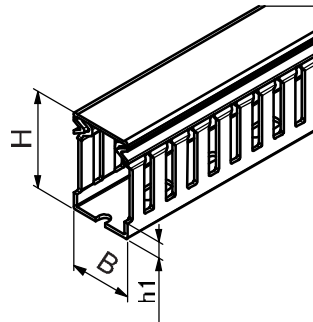
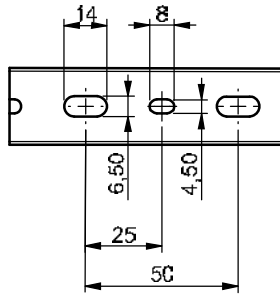

B 80, 100

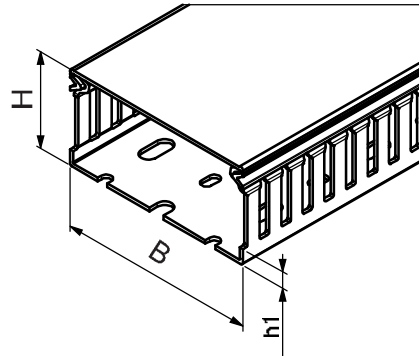
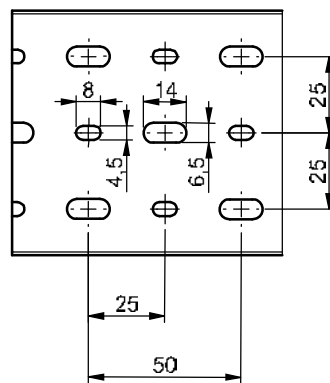

H = 60 mm
H = 80 mm
H = 100 mm

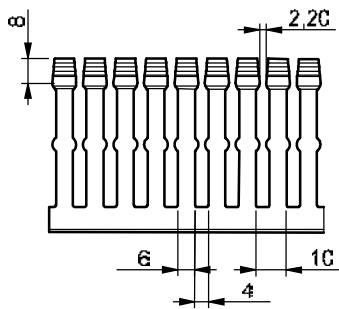

B 25, 30, 40, 60

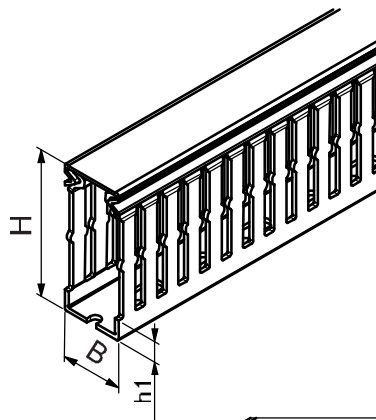
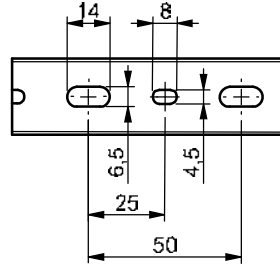

B 80, 100, 120, 150

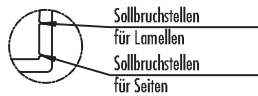
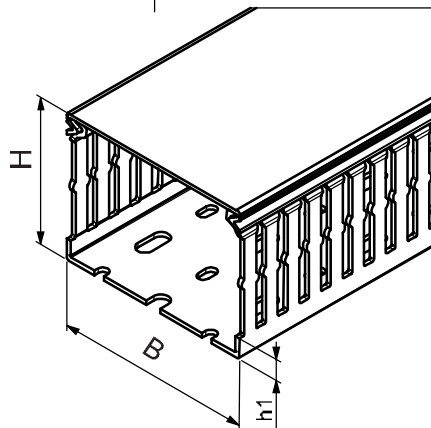
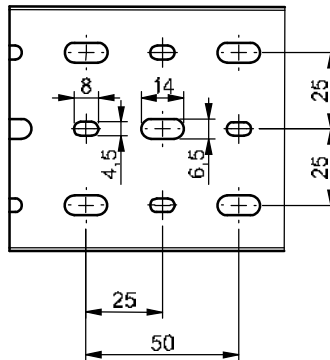

Bodenstanzung gemäss NF EN 50085

| | | | | | |
|---------|----|----|----|----|-----|
| H (mm) | 30 | 40 | 60 | 80 | 100 |
| h1 (mm) | 5 | 7 | 9 | 11 | 16 |

Verdrahtungskanäle SES mit senkrechter Seiten- und Bodenstanzung





GN-HF-A6/4

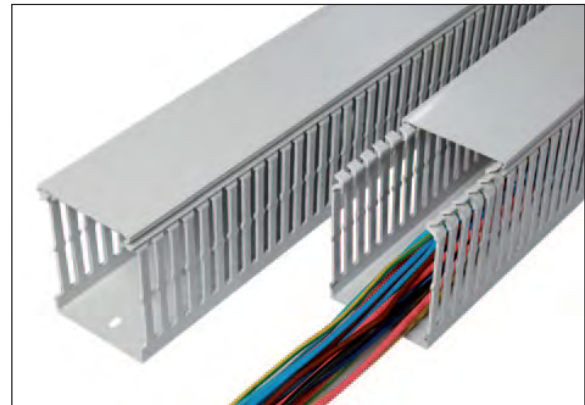

GN-HF-A6/4

| | |
|----------------------------------|--|
| Material: | PC/ABS, Halogenfrei |
| Farbe: | hellgrau RAL7035 |
| Gebrauchstemperaturen: | -25 bis +90°C |
| Durchgangswiderstand: | 10 ¹⁵ Ω.cm |
| Durchschlagfestigkeit: | 35kV/mm |
| Eigenschaften: | V0 UL94 NF F 16-101/102 : I3/F2 DIN 5510-2 : S4-SR2-ST2 EN 45545-2 : R22 HL3, R23 HL3 |
| Standardlänge: | 2 Meter |
| Doppelseitiges Klebeband: | auf Anfrage |
| Mindestmenge: | 1 komplette Verpackung (inkl. Deckel) |



| Typ | Verdrahtungs- kanal Art. Nr. |  m | Aussenmasse | | Anzahl Kabel pro Verdrahtungskanal (Füllung 50 %) | | | Deckel (Einzel) Art. Nr. |  m |
|---------------------|------------------------------------|--|-------------|---------|--|------------------------|------------------------|--------------------------------|--|
| | | | H mm | B mm | 1 mm ² | 1,5 mm ² | 2,5 mm ² | | |
| GN-HF-A6/4 30 x 30 | 0850 0133 025 | 48 | 30 | 30 | 48 | 39 | 33 | 0850 0505 025 | 24 |
| GN-HF-A6/4 40 x 25 | 0850 0141 025 | 48 | 40 | 25 | 52 | 43 | 36 | 0850 0500 025 | 48 |
| GN-HF-A6/4 40 x 40 | 0850 0142 025 | 32 | 40 | 40 | 94 | 77 | 64 | 0850 0510 025 | 24 |
| GN-HF-A6/4 40 x 60 | 0850 0143 025 | 24 | 40 | 60 | 149 | 122 | 102 | 0850 0520 025 | 24 |
| GN-HF-A6/4 40 x 80 | 0850 0144 025 | 24 | 40 | 80 | 204 | 168 | 140 | 0850 0530 025 | 24 |
| GN-HF-A6/4 60 x 25 | 0850 0151 025 | 48 | 60 | 25 | 80 | 66 | 55 | 0850 0500 025 | 48 |
| GN-HF-A6/4 60 x 40 | 0850 0152 025 | 32 | 60 | 40 | 144 | 118 | 99 | 0850 0510 025 | 24 |
| GN-HF-A6/4 60 x 60 | 0850 0153 025 | 24 | 60 | 60 | 229 | 188 | 157 | 0850 0520 025 | 24 |
| GN-HF-A6/4 60 x 80 | 0850 0154 025 | 16 | 60 | 80 | 313 | 257 | 215 | 0850 0530 025 | 24 |
| GN-HF-A6/4 80 x 25 | 0850 0161 025 | 24 | 80 | 25 | 107 | 88 | 74 | 0850 0500 025 | 48 |
| GN-HF-A6/4 80 x 40 | 0850 0162 025 | 24 | 80 | 40 | 193 | 159 | 133 | 0850 0510 025 | 24 |
| GN-HF-A6/4 80 x 60 | 0850 0163 025 | 24 | 80 | 60 | 308 | 253 | 211 | 0850 0520 025 | 24 |
| GN-HF-A6/4 80 x 80 | 0850 0164 025 | 16 | 80 | 80 | 422 | 347 | 290 | 0850 0530 025 | 24 |
| GN-HF-A6/4 80 x 100 | 0850 0165 025 | 12 | 80 | 100 | 537 | 441 | 369 | 0850 0540 025 | 12 |
| GN-HF-A6/4 100 x 30 | 0850 0170 025 | 32 | 100 | 30 | 169 | 138 | 116 | 0850 0505 025 | 24 |
| GN-HF-A6/4 100 x 60 | 0850 0172 025 | 16 | 100 | 60 | 384 | 316 | 264 | 0850 0520 025 | 24 |

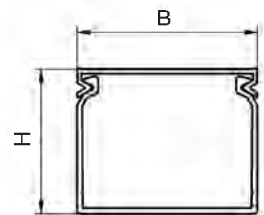

C3/1-01

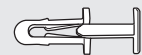

C3/1-01



C3/5-01



C3/6-01

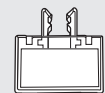

GN-HF-A6/4

H = 30 mm
H = 40 mm

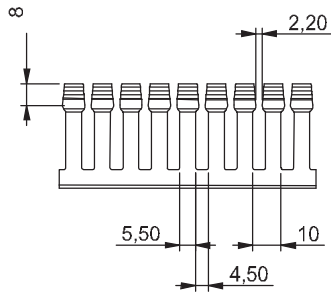

B 25, 30, 40, 60

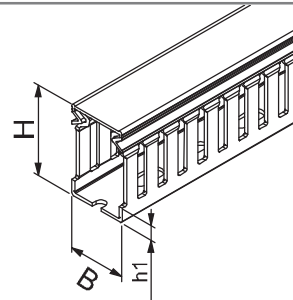
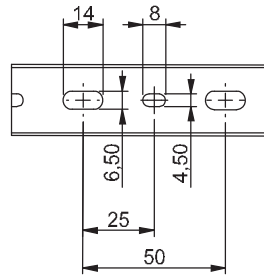

B 80

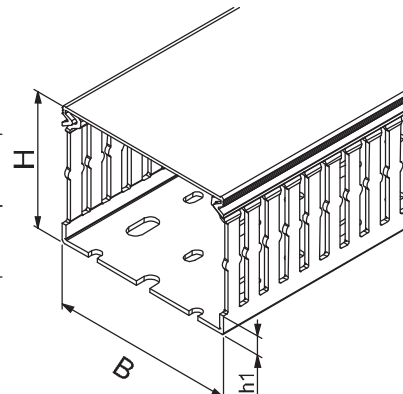
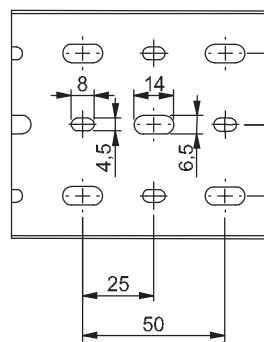

H = 60 mm
H = 80 mm
H = 100 mm

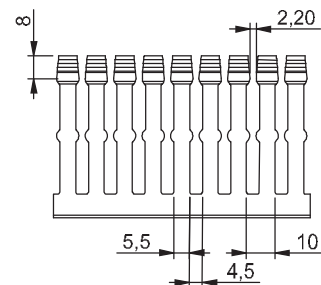

B 25, 30, 40, 60

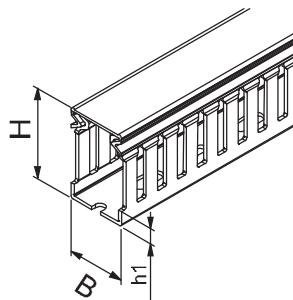
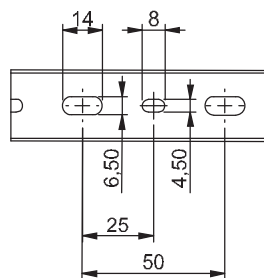

B 80, 100

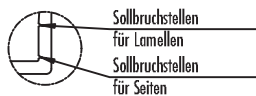
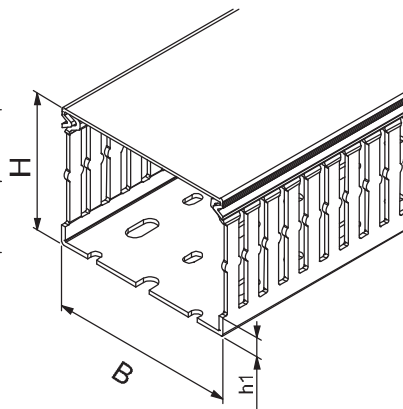
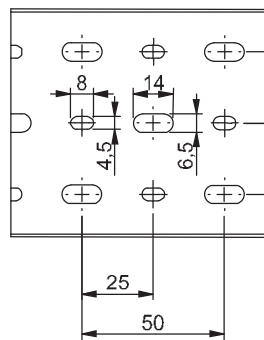

Bodenstanzung gemäss NF EN 50085

| | | | | | |
|---------|-----|-----|-----|------|-----|
| H (mm) | 30 | 40 | 60 | 80 | 100 |
| h1 (mm) | 4,3 | 6,5 | 8,3 | 10,3 | 15 |

Verdrahtungskanäle SES mit senkrechter Seiten- und Bodenstanzung





GN-A6/4

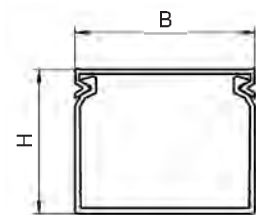

GN-A6/4 blau

| | |
|----------------------------------|--|
| Material: | Hart-PVC Qualität 9051 LF |
| Farbe: | himmelblau, RAL 5015 |
| Gebrauchstemperaturen: | -5 bis +65°C |
| Dichte: | 1,54 |
| Durchgangswiderstand: | 10 ¹⁶ Ω.cm |
| Durchschlagfestigkeit: | 15 kV/mm |
| Eigenschaften: | V0 UL94 |
| Standardlänge: | 2 Meter |
| Doppelseitiges Klebeband: | auf Anfrage |
| Mindestmenge: | 1 komplette Verpackung (inkl. Deckel) |
| Anwendung: | für den eigensicheren Bereich |



| Typ | Verdrahtungs- kanal Art. Nr. |  m | Aussenmasse | | Anzahl Kabel pro Verdrahtungskanal (Füllung 50 %) | | | Deckel (Einzel) Art. Nr. |  m | |
|---------|------------------------------------|---|-------------|---------|--|------------------------|------------------------|--------------------------------|---|----|
| | | | H mm | B mm | 1 mm ² | 1,5 mm ² | 2,5 mm ² | | | |
| GN-A6/4 | 30 x 25 | 0839 0131 083 | 60 | 30 | 25 | 37 | 31 | 26 | 0839 0500 083 | 48 |
| GN-A6/4 | 40 x 25 | 0839 0141 083 | 48 | 40 | 25 | 52 | 43 | 36 | 0839 0500 083 | 48 |
| GN-A6/4 | 40 x 30 | 0839 0146 083 | 36 | 40 | 30 | 66 | 54 | 45 | 0839 0505 083 | 24 |
| GN-A6/4 | 40 x 40 | 0839 0142 083 | 32 | 40 | 40 | 94 | 77 | 64 | 0839 0510 083 | 24 |
| GN-A6/4 | 60 x 30 | 0839 0157 083 | 40 | 60 | 30 | 102 | 83 | 70 | 0839 0505 083 | 24 |
| GN-A6/4 | 60 x 40 | 0839 0152 083 | 32 | 60 | 40 | 144 | 118 | 99 | 0839 0510 083 | 24 |
| GN-A6/4 | 60 x 60 | 0839 0153 083 | 24 | 60 | 60 | 229 | 188 | 157 | 0839 0520 083 | 24 |
| GN-A6/4 | 60 x 80 | 0839 0154 083 | 16 | 60 | 80 | 313 | 257 | 215 | 0839 0530 083 | 24 |
| GN-A6/4 | 80 x 30 | 0839 0167 083 | 24 | 80 | 30 | 136 | 112 | 94 | 0839 0505 083 | 24 |
| GN-A6/4 | 80 x 40 | 0839 0162 083 | 24 | 80 | 40 | 193 | 159 | 133 | 0839 0510 083 | 24 |
| GN-A6/4 | 80 x 60 | 0839 0163 083 | 24 | 80 | 60 | 308 | 253 | 211 | 0839 0520 083 | 24 |
| GN-A6/4 | 80 x 80 | 0839 0164 083 | 16 | 80 | 80 | 422 | 347 | 290 | 0839 0530 083 | 24 |
| GN-A6/4 | 80 x 100 | 0839 0165 083 | 12 | 80 | 100 | 537 | 441 | 369 | 0839 0540 083 | 12 |
| GN-A6/4 | 100 x 60 | 0839 0172 083 | 16 | 100 | 60 | 384 | 316 | 264 | 0839 0520 083 | 24 |
| GN-A6/4 | 100 x 100 | 0839 0174 083 | 16 | 100 | 100 | 673 | 553 | 462 | 0839 0540 083 | 12 |

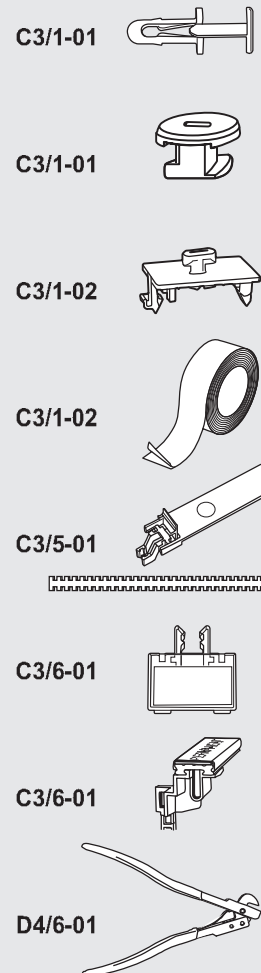

GN-A6/4 blau

H = 30 mm

H = 40 mm

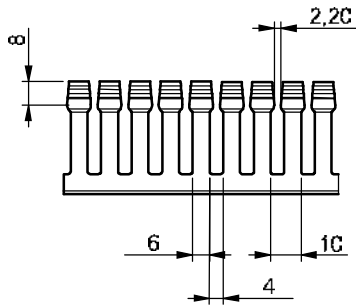

B 25, 30, 40, 60

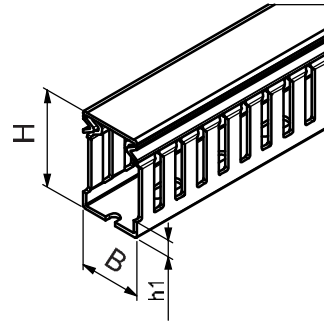
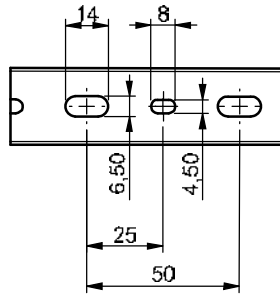

H = 60 mm

H = 80 mm

H = 100 mm

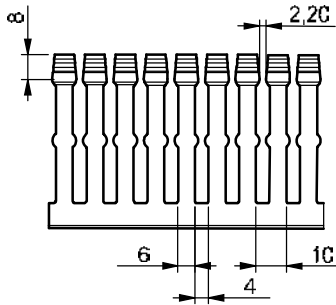

B 25, 30, 40, 60

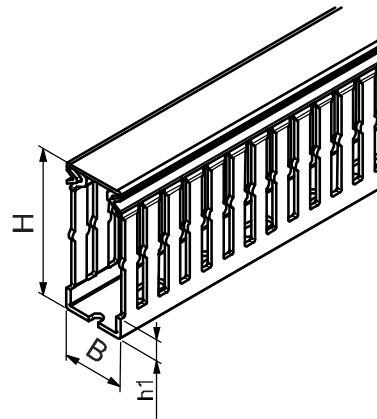
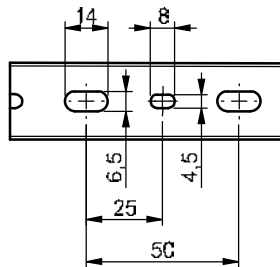

B 80, 100

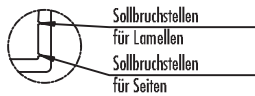
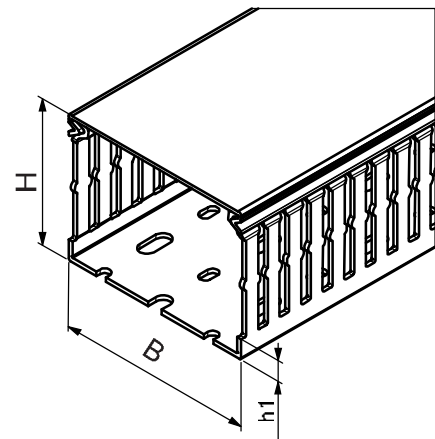
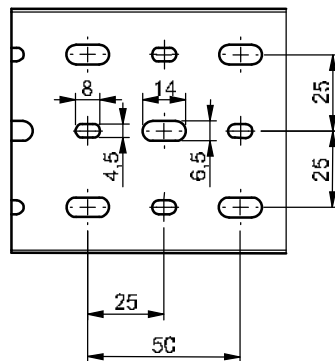

Bodenstanzung gemäss NF EN 50085

| | | | | | |
|---------|----|----|----|----|-----|
| H (mm) | 30 | 40 | 60 | 80 | 100 |
| h1 (mm) | 5 | 7 | 9 | 11 | 16 |

Verdrahtungskanäle SES mit senkrechter Seiten- und Bodenstanzung



GF-DIN-A7/5

GF-DIN-A6/4



GF-DIN-A7/5 -A6/4

| | |
|----------------------------------|---------------------------------------|
| Material: | Hart-PVC Qualität 9051 LF |
| Farben: | grau RAL7030 - schwarz |
| Gebrauchstemperaturen: | -5 bis +65°C |
| Durchgangswiderstand: | 10 ¹⁶ Ω.cm |
| Durchschlagfestigkeit: | 15kV/mm |
| Eigenschaften: | V0 UL94 |
| Standardlänge: | 2 Meter |
| Doppelseitiges Klebeband: | auf Anfrage |
| Mindestmenge: | 1 komplette Verpackung (inkl. Deckel) |

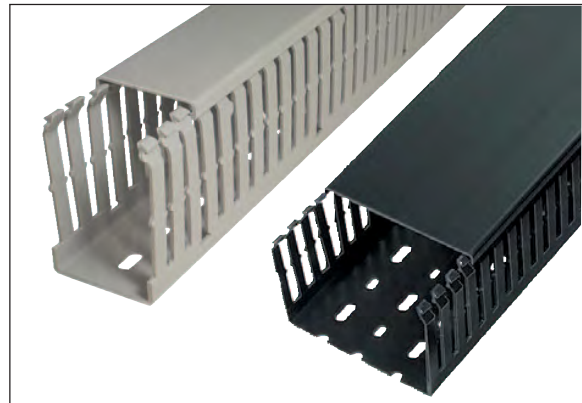



Bestellbeispiel:

Farben: 013 010

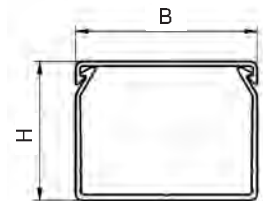
| Code Gruppe | Detail Artikel | Code Farbe |
|-------------|----------------|------------|
| 0845 | xxxxxx | xxxx |



| Typ | Verdrahtungs- kanal Art. Nr. |  m | Ausßenmasse | | Anzahl Kabel pro Verdrahtungskanal (Füllung 50 %) | | | Deckel (Einzel) Art. Nr. |  m |
|------------------------|------------------------------------|--|-------------|---------|---|------------------------|------------------------|--------------------------------|--|
| | | | H mm | B mm | 1 mm ² | 1,5 mm ² | 2,5 mm ² | | |
| GF-DIN-A7/5 25 x 25 | 0845 0031 *** | 48 | 23 | 23 | 25 | 21 | 17 | 0845 0640 *** | 48 |
| GF-DIN-A7/5 37,5x 25 | 0845 0041 *** | 48 | 35,5 | 23 | 44 | 36 | 30 | 0845 0640 *** | 48 |
| GF-DIN-A7/5 37,5x 37,5 | 0845 0051 *** | 24 | 35,5 | 35,5 | 74 | 61 | 51 | 0845 0645 *** | 24 |
| GF-DIN-A7/5 37,5x 50 | 0845 0061 *** | 24 | 35,5 | 48 | 105 | 86 | 72 | 0845 0650 *** | 24 |
| GF-DIN-A7/5 50 x 25 | 0845 0131 *** | 48 | 48 | 23 | 62 | 51 | 42 | 0845 0640 *** | 48 |
| GF-DIN-A7/5 50 x 37,5 | 0845 0141 *** | 24 | 48 | 35,5 | 104 | 85 | 71 | 0845 0645 *** | 24 |
| GF-DIN-A7/5 50 x 50 | 0845 0151 *** | 24 | 48 | 48 | 146 | 120 | 100 | 0845 0650 *** | 24 |
| GF-DIN-A7/5 50 x 75 | 0845 0152 *** | 24 | 48 | 73 | 230 | 189 | 158 | 0845 0655 *** | 24 |
| GF-DIN-A7/5 50 x 100 | 0845 0153 *** | 12 | 48 | 98 | 315 | 259 | 216 | 0845 0630 *** | 12 |
| GF-DIN-A7/5 50 x 125 | 0845 0154 *** | 12 | 48 | 123 | 399 | 328 | 274 | 0845 0665 *** | 12 |
| GF-DIN-A7/5 75 x 25 | 0845 0211 *** | 48 | 73 | 25 | 101 | 83 | 69 | 0845 0640 *** | 48 |
| GF-DIN-A7/5 75 x 37,5 | 0845 0221 *** | 24 | 73 | 35,5 | 161 | 132 | 111 | 0845 0645 *** | 24 |
| GF-DIN-A7/5 75 x 50 | 0845 0231 *** | 24 | 73 | 48 | 227 | 186 | 156 | 0845 0650 *** | 24 |
| GF-DIN-A7/5 75 x 75 | 0845 0241 *** | 24 | 73 | 73 | 358 | 294 | 246 | 0845 0655 *** | 24 |
| GF-DIN-A7/5 75 x 100 | 0845 0251 *** | 12 | 73 | 98 | 489 | 402 | 336 | 0845 0630 *** | 12 |
| GF-DIN-A7/5 75 x 125 | 0845 0261 *** | 12 | 73 | 123 | 620 | 509 | 426 | 0845 0665 *** | 12 |
| GF-DIN-A6/4 100 x 50 | 0845 0286 013 | 24 | 100 | 48 | 304 | 250 | 209 | 0845 0650 013 | 24 |
| GF-DIN-A6/4 100 x 75 | 0845 0296 013 | 12 | 100 | 73 | 484 | 398 | 333 | 0845 0655 013 | 24 |

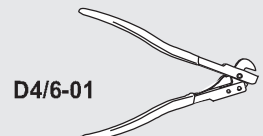



GF-DIN-A7/5

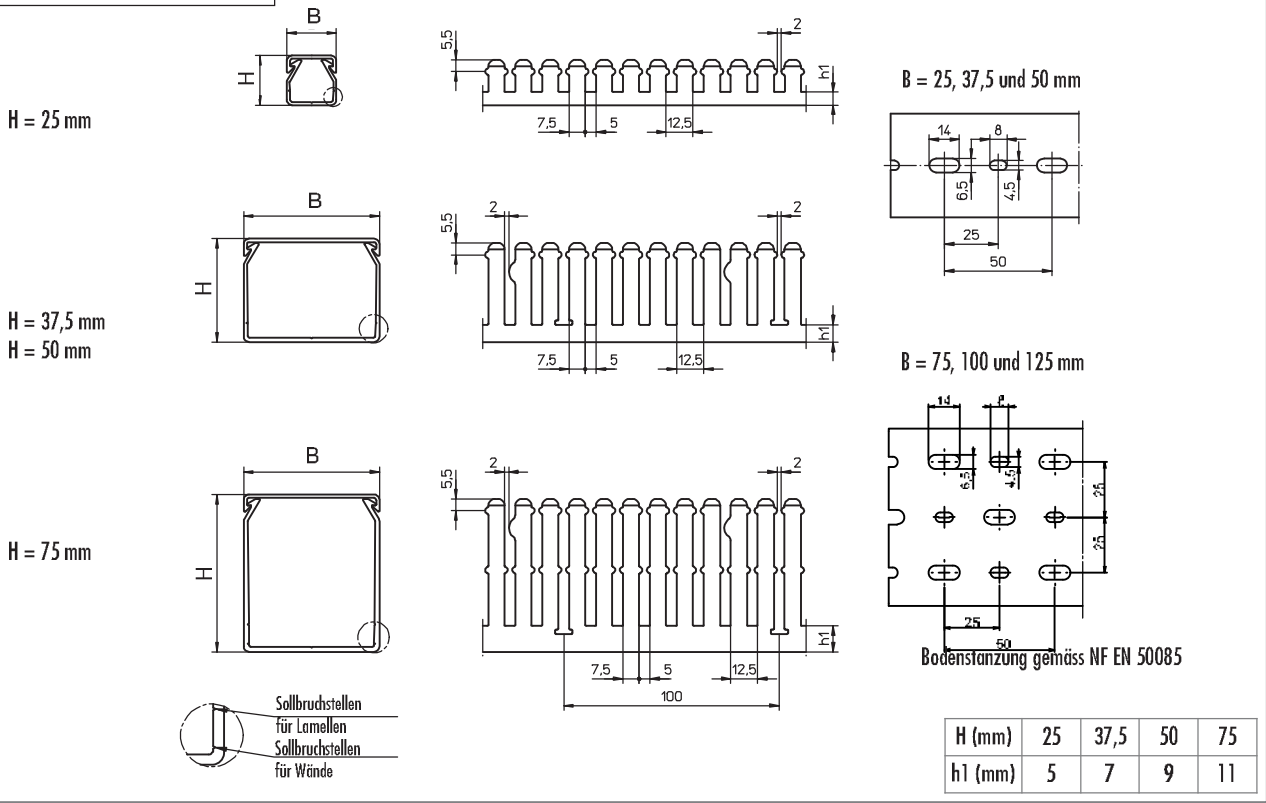

GF-DIN-A6/4

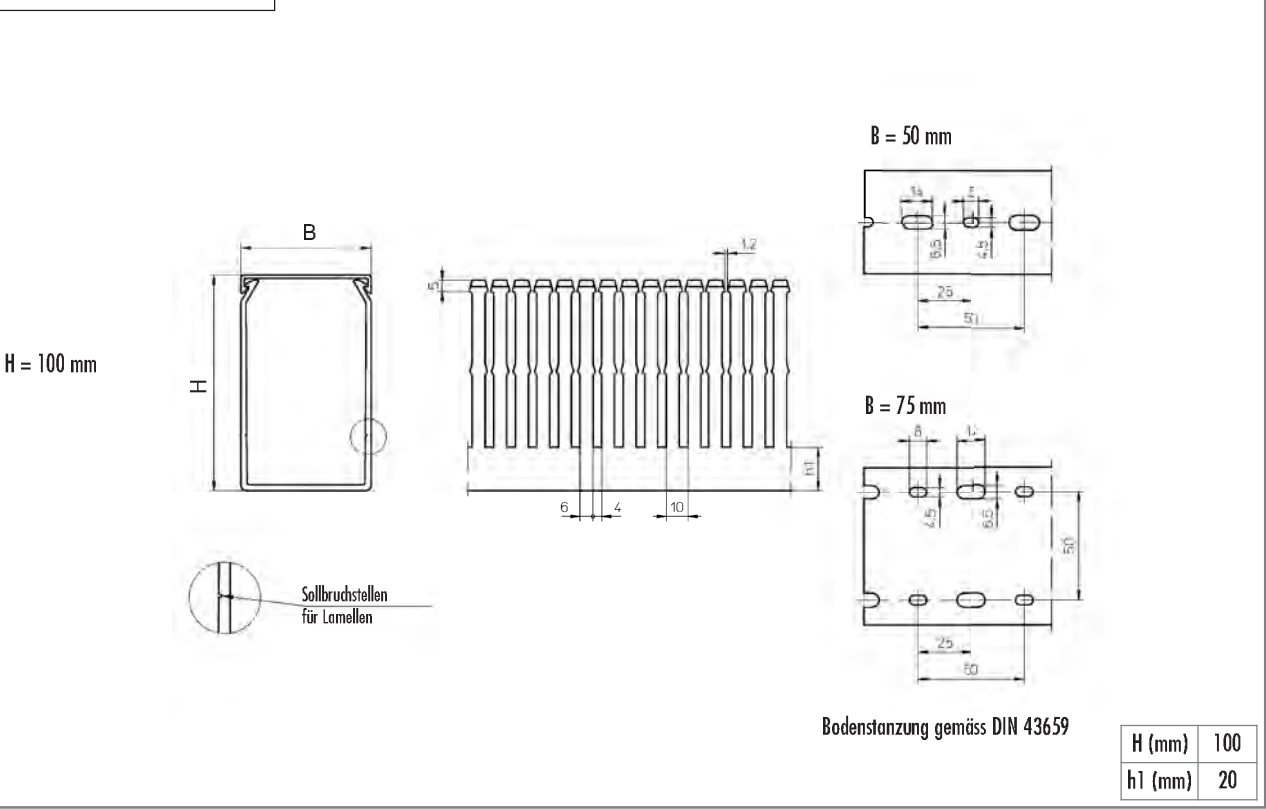

Verdrahtungskanäle SES Halogenfrei mit senkrechter Seiten- und Bodenstanzung



GF-DIN-SH-A7/5



GF-DIN-SH-A7/5

| | |
|----------------------------------|---|
| Material: | PC/ABS |
| Farbe: | hellgrau RAL7035 |
| Gebrauchstemperaturen: | -25 bis +90°C |
| Durchgangswiderstand: | 10 ¹⁵ Ω.cm |
| Durchschlagfestigkeit: | 35 kV/mm |
| Eigenschaften: | V0 UL94 - EN 45545 NF F16-101/102 - DIN 5510 |
| Empfehlungen: | kein Kontakt mit Ölen oder Fetten |
| Standardlänge: | 2 Meter |
| Doppelseitiges Klebeband: | auf Anfrage |
| Mindestmenge: | 1 komplette Verpackung (inkl. Deckel) |



| Typ | Verdrahtungs- kanal Art. Nr. | m | Ausßenmasse | | Anzahl Kabel pro Verdrahtungskanal (Füllung 50 %) | | | Deckel (Einzel) Art. Nr. | m |
|---------------------------|------------------------------------|----|-------------|---------|---|------------------------|------------------------|--------------------------------|----|
| | | | H mm | B mm | 1 mm ² | 1,5 mm ² | 2,5 mm ² | | |
| GF-DIN-SH-A7/5 25 x 25 | 0848 0031 013 | 48 | 23 | 23 | 25 | 21 | 17 | 0848 0640 013 | 12 |
| GF-DIN-SH-A7/5 37,5x 25 | 0848 0041 013 | 48 | 35,5 | 23 | 44 | 36 | 30 | 0848 0640 013 | 12 |
| GF-DIN-SH-A7/5 37,5x 37,5 | 0848 0051 013 | 24 | 35,5 | 35,5 | 74 | 61 | 51 | 0848 0645 013 | 12 |
| GF-DIN-SH-A7/5 37,5x 50 | 0848 0053 013 | 24 | 35,5 | 48 | 105 | 86 | 72 | 0848 0650 013 | 12 |
| GF-DIN-SH-A7/5 50 x 25 | 0848 0131 013 | 48 | 48 | 23 | 62 | 51 | 42 | 0848 0640 013 | 12 |
| GF-DIN-SH-A7/5 50 x 37,5 | 0848 0141 013 | 24 | 48 | 35,5 | 104 | 85 | 71 | 0848 0645 013 | 12 |
| GF-DIN-SH-A7/5 50 x 50 | 0848 0151 013 | 24 | 48 | 48 | 146 | 120 | 100 | 0848 0650 013 | 12 |
| GF-DIN-SH-A7/5 50 x 75 | 0848 0152 013 | 24 | 48 | 73 | 230 | 189 | 158 | 0848 0655 013 | 12 |
| GF-DIN-SH-A7/5 50 x 100 | 0848 0153 013 | 12 | 48 | 98 | 315 | 259 | 216 | 0848 0660 013 | 12 |
| GF-DIN-SH-A7/5 75 x 25 | 0848 0211 013 | 48 | 73 | 23 | 101 | 83 | 69 | 0848 0640 013 | 12 |
| GF-DIN-SH-A7/5 75 x 37,5 | 0848 0221 013 | 24 | 73 | 35,5 | 161 | 132 | 111 | 0848 0645 013 | 12 |
| GF-DIN-SH-A7/5 75 x 50 | 0848 0231 013 | 24 | 73 | 48 | 227 | 186 | 156 | 0848 0650 013 | 12 |
| GF-DIN-SH-A7/5 75 x 75 | 0848 0241 013 | 24 | 73 | 73 | 358 | 294 | 246 | 0848 0655 013 | 12 |
| GF-DIN-SH-A7/5 75 x 100 | 0848 0251 013 | 12 | 73 | 98 | 489 | 402 | 336 | 0848 0660 013 | 12 |
| GF-DIN-SH-A7/5 75 x 125 | 0848 0261 013 | 12 | 73 | 123 | 620 | 509 | 426 | 0848 0665 013 | 12 |

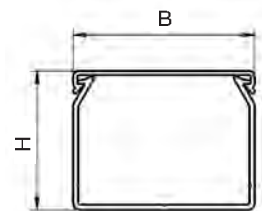

C3/1-01

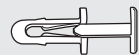

C3/1-01



C3/1-02

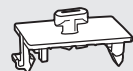

C3/1-02



C3/5-01

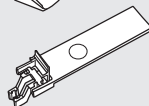

C3/6-01

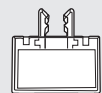

C3/6-01

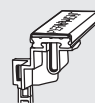

D4/6-01

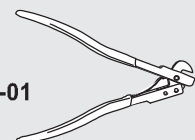

Verdrahtungskanäle SES
mit senkrechter Seiten- und Bodenstanzung



GF-DIN-SH-A7/5



GF-DIN-SH-A7/5

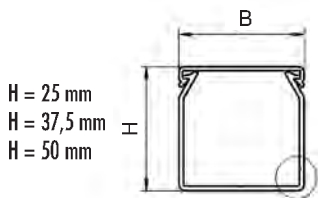

H = 25 mm
H = 37,5 mm
H = 50 mm

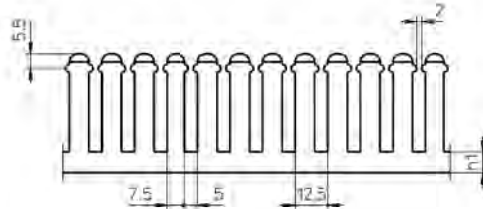

B = 25, 37,5 und 50 mm

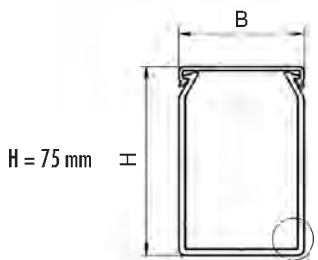
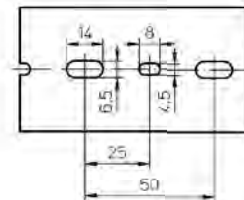

H = 75 mm

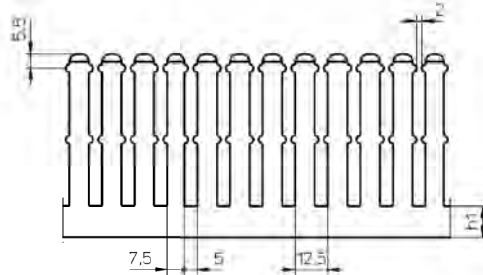

B = 75, 100 und 125 mm

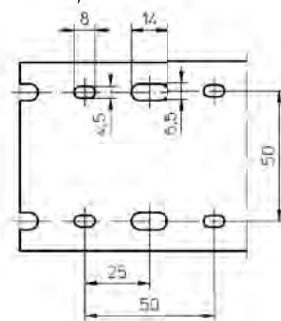

Sollbruchstellen
für Lamellen

Bodenstanzung gemäss DIN 43659

| | | | | |
|---------|----|------|----|----|
| H (mm) | 25 | 37,5 | 50 | 75 |
| h1 (mm) | 6 | 8 | 8 | 12 |

Verdrahtungskanäle SES mit senkrechter Seiten- und Bodenstanzung



GF-DIN-C-A12/8



GF-DIN-C-A12/8

| | |
|----------------------------------|---------------------------------------|
| Material: | Hart-PVC Qualität 9051 LF |
| Farben: | grau RAL7030 - schwarz |
| Gebrauchstemperaturen: | -5 bis +65°C |
| Durchgangswiderstand: | 10 ¹⁶ Ω.cm |
| Durchschlagfestigkeit: | 15 kV/mm |
| Eigenschaften: | V0 UL94 |
| Standardlänge: | 2 Meter |
| Doppelseitiges Klebeband: | auf Anfrage |
| Mindestmenge: | 1 komplette Verpackung (inkl. Deckel) |

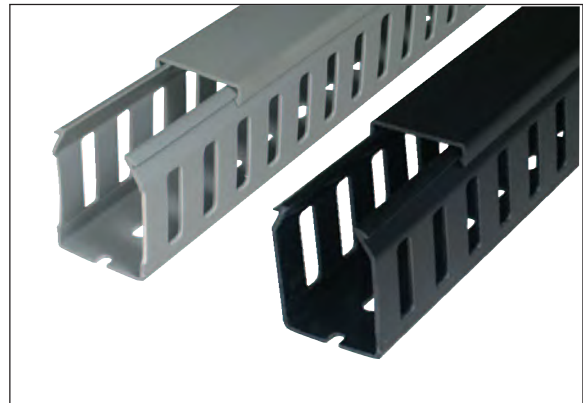



Bestellbeispiel:

Farben: 013 010

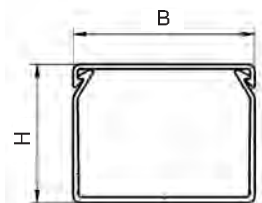
| Code Gruppe | Detail Artikel | Code Farbe |
|-------------|-----------------|------------|
| 0845 | x x x x x x x x | x x x x |





| Typ | Verdrahtungs- kanal Art. Nr. |  m | Ausßenmasse | | Anzahl Kabel pro Verdrahtungskanal (Füllung 50 %) | | | Deckel (Einzel) Art. Nr. |  m | |
|----------------|------------------------------------|---|-------------|---------|---|------------------------|------------------------|--------------------------------|---|----|
| | | | H mm | B mm | 1 mm ² | 1,5 mm ² | 2,5 mm ² | | | |
| GF-DIN-C-A12/8 | 37,5x 25 | 0845 0046 *** | 48 | 35,5 | 23 | 44 | 36 | 30 | 0845 0640 *** | 48 |
| GF-DIN-C-A12/8 | 37,5x 37,5 | 0845 0056 *** | 24 | 35,5 | 35,5 | 74 | 61 | 51 | 0845 0645 *** | 24 |
| GF-DIN-C-A12/8 | 37,5x 50 | 0845 0066 *** | 24 | 35,5 | 48 | 105 | 86 | 72 | 0845 0650 *** | 24 |
| GF-DIN-C-A12/8 | 50 x 25 | 0845 0136 *** | 48 | 48 | 23 | 62 | 51 | 42 | 0845 0640 *** | 48 |
| GF-DIN-C-A12/8 | 50 x 37,5 | 0845 0146 *** | 24 | 48 | 35,5 | 104 | 85 | 71 | 0845 0645 *** | 24 |
| GF-DIN-C-A12/8 | 50 x 50 | 0845 0166 *** | 24 | 48 | 48 | 146 | 120 | 100 | 0845 0650 *** | 24 |
| GF-DIN-C-A12/8 | 50 x 75 | 0845 0167 *** | 24 | 48 | 73 | 230 | 189 | 158 | 0845 0655 *** | 24 |
| GF-DIN-C-A12/8 | 50 x100 | 0845 0168 *** | 12 | 48 | 98 | 315 | 259 | 216 | 0845 0630 *** | 12 |
| GF-DIN-C-A12/8 | 50 x125 | 0845 0169 *** | 12 | 48 | 123 | 399 | 328 | 274 | 0845 0665 *** | 12 |
| GF-DIN-C-A12/8 | 75 x 25 | 0845 0216 *** | 48 | 73 | 25 | 101 | 83 | 69 | 0845 0640 *** | 48 |
| GF-DIN-C-A12/8 | 75 x 37,5 | 0845 0226 *** | 24 | 73 | 35,5 | 161 | 132 | 111 | 0845 0645 *** | 24 |
| GF-DIN-C-A12/8 | 75 x 50 | 0845 0236 *** | 24 | 73 | 48 | 227 | 186 | 156 | 0845 0650 *** | 24 |
| GF-DIN-C-A12/8 | 75 x 75 | 0845 0246 *** | 24 | 73 | 73 | 358 | 294 | 246 | 0845 0655 *** | 24 |
| GF-DIN-C-A12/8 | 75 x100 | 0845 0256 *** | 12 | 73 | 98 | 489 | 402 | 336 | 0845 0630 *** | 12 |
| GF-DIN-C-A12/8 | 75 x125 | 0845 0266 *** | 12 | 73 | 123 | 620 | 509 | 426 | 0845 0665 *** | 12 |

C3/1-01 

C3/1-01 

C3/1-02 

C3/1-02 

C3/5-01 

C3/6-01 

D4/6-01 

Verdrahtungskanäle SES
mit senkrechter Seiten- und Bodenstanzung



GF-DIN-C-A12/8



GF-DIN-C-A12/8

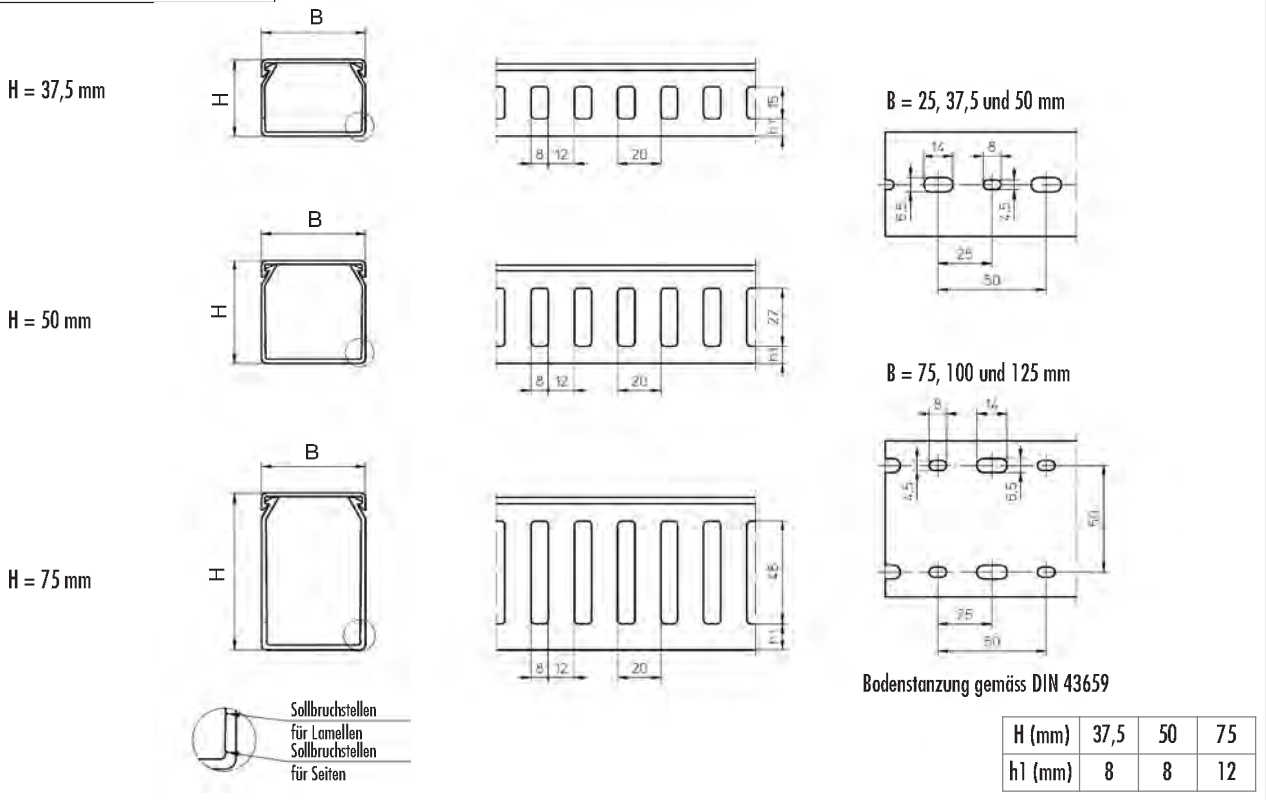

Verdrahtungskanäle SES mit senkrechter Seiten- und Bodenstanzung





GF-A12/8

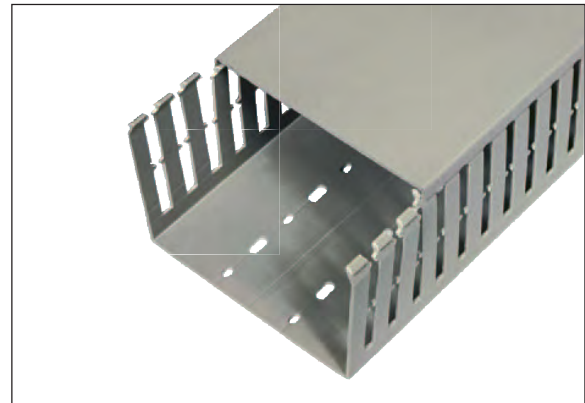

GF-A12/8

| | |
|----------------------------------|--|
| Material: | hart-PVC Qualität 9051 LF |
| Farbe: | grau RAL7030 |
| Gebrauchstemperaturen: | -5 bis +65°C |
| Dichte: | 1,56 |
| Durchgangswiderstand: | 10 ¹⁵ Ω.cm |
| Durchschlagfestigkeit: | 15 kV/mm |
| Eigenschaften: | V0 UL94 CSTB:M2 |
| Standardlänge: | 2 Meter |
| Doppelseitiges Klebeband: | auf Anfrage |
| Mindestmenge: | 1 komplette Verpackung (inkl. Deckel) |
| Anwendung: | für Kabel mit grossen Durchmessern |



| Typ | Verdrahtungs- kanal Art. Nr. |  m | Aussenmasse | | Anzahl Kabel pro Verdrahtungskanal (Füllung 50 %) | | | Deckel (Einzel) Art. Nr. |  m |
|--------------------|------------------------------------|--|-------------|---------|---|------------------------|------------------------|--------------------------------|--|
| | | | H mm | B mm | 1 mm ² | 1,5 mm ² | 2,5 mm ² | | |
| GF-A12/8 100 x 100 | 0845 0276 013 | 12 | 100 | 100 | 671 | 551 | 461 | 0845 0630 013 | 12 |
| GF-A12/8 100 x 150 | 0845 0273 013 | 12 | 100 | 150 | 1043 | 856 | 716 | 0845 0636 013 | 12 |

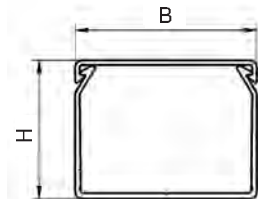



C3/1-01 

C3/1-01 

C3/1-02 

C3/1-02 

C3/5-01 

C3/6-01 

C3/6-01 

D4/6-01 



GF-A12/8

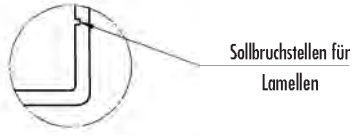
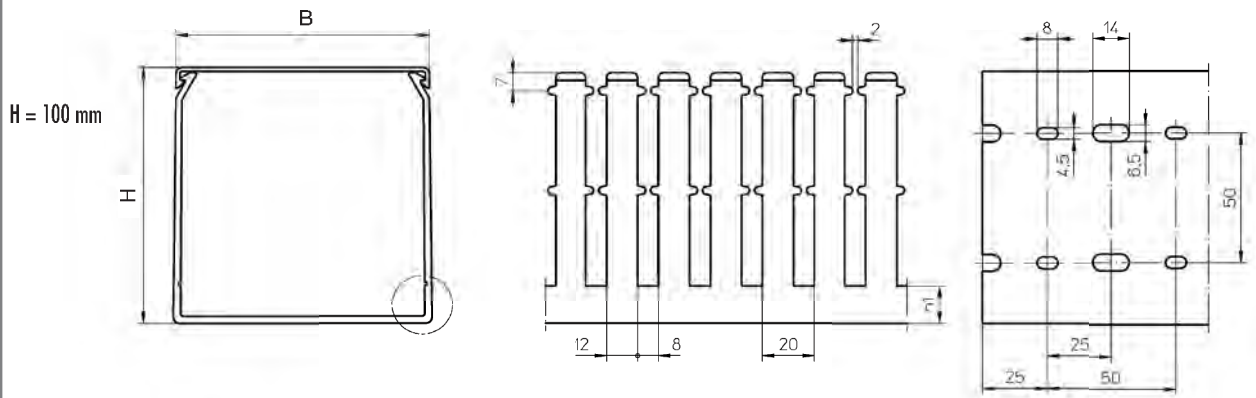

| | |
|---------|-----|
| H (mm) | 100 |
| h1 (mm) | 15 |



GF-DIN-PPDA

| | |
|----------------------------------|--|
| Material: | Hart-PVC Qualität 9051 |
| Farbe: | grau RAL7030 |
| Gebrauchstemperaturen: | -5 bis +65°C |
| Dichte: | 1,56 |
| Durchgangswiderstand: | 10 ¹⁶ Ω.cm |
| Durchschlagfestigkeit: | 15kV/mm |
| Eigenschaften: | V0 UL94 CSTB:M2 |
| Standardlänge: | 2 Meter |
| Doppelseitiges Klebeband: | auf Anfrage |
| Mindestmenge: | 1 komplette Verpackung (inkl. Deckel) |



| Typ | Art. Nr. | Aussermasse | | m |
|----------------------|---------------|-------------|---------|----|
| | | H mm | B mm | |
| GF-DIN-PPDA 50 x 50 | 0845 0713 013 | 48 | 48 | 24 |
| GF-DIN-PPDA 50 x 75 | 0845 0714 013 | 48 | 73 | 24 |
| GF-DIN-PPDA 50 x 100 | 0845 0715 013 | 48 | 98 | 12 |
| GF-DIN-PPDA 50 x 125 | 0845 0716 013 | 48 | 123 | 12 |

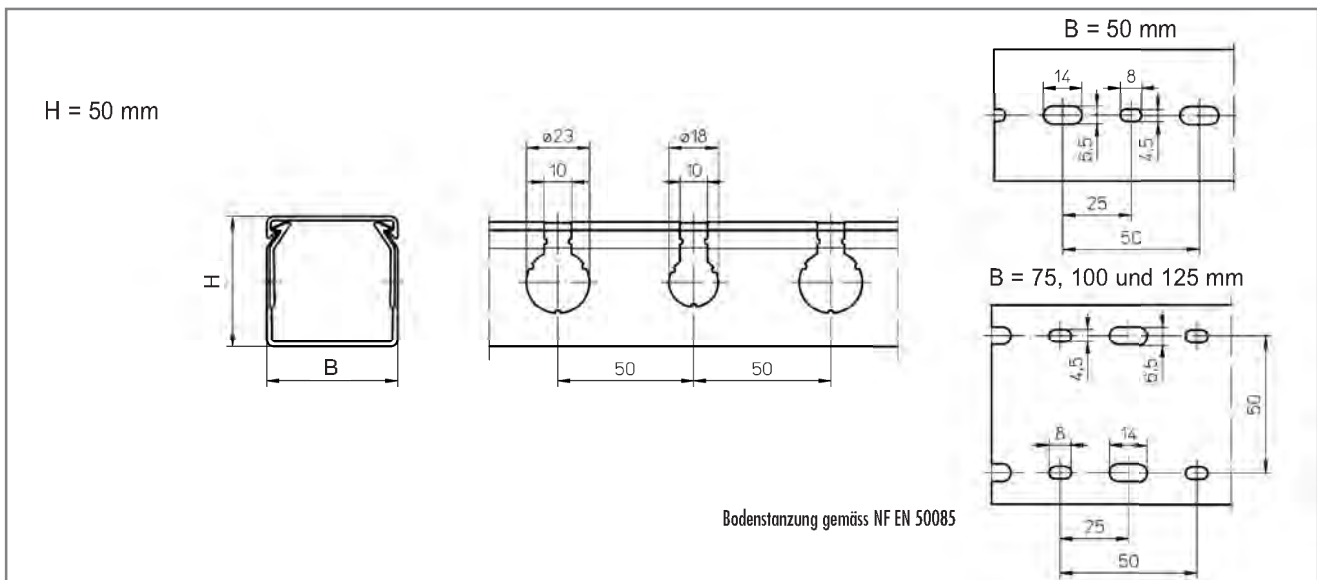

Die seitlichen Stanzungen sind für den Anschluss der Spiralschläuche ICO Nr. 13 und Nr. 16 gemäss Norm NF C 68-133 geeignet.

Können ebenfalls verwendet werden:

- ELECTROFLEX Verschraubungen Seite A7/2-01,
- PLIOLOCK Verschraubungen Seite A7/5-01.

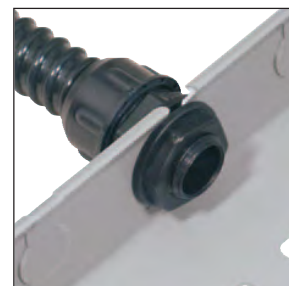

Halb-Standard Produkte - auf Anfrage

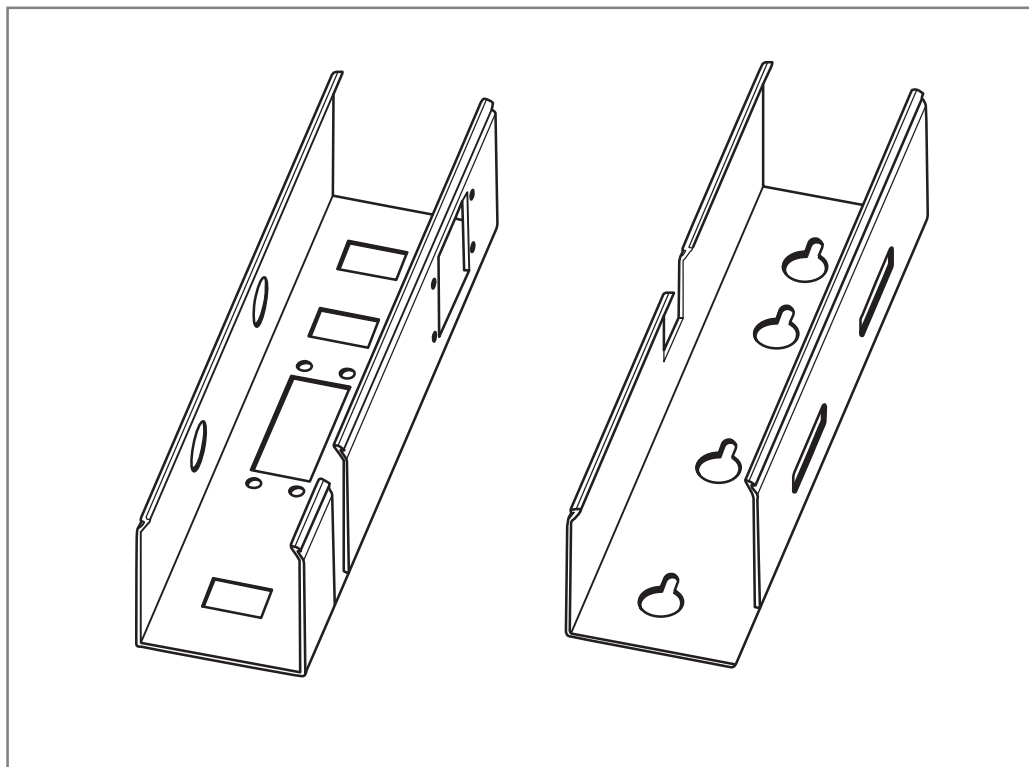

SES-STERLING unterbreitet Ihnen auf Anfrage ein Angebot für Spezial-Kabelkanäle wie:

Kabelkanäle mit Spezial Seiten- oder Bodenstanzungen
Kabelkanäle in Speziallängen

Stanzungen an allen Standard Kabelkanälen möglich. SES-STERLING kann auf Anfrage neue Kabelkanäle mit Spezialprofil entwickeln.

Bei Sonderausführungen benötigen wir Pläne sowie Mengen-, Farben- und Materialangaben.

Artikelnummer: 0845 0999 000

Um ein schnelles Schneiden der Verdrahtungskanäle zu ermöglichen, stellt Ihnen SES-STERLING eine Auswahl Spezialwerkzeuge zur Verfügung.



Verdrahtungskanalschneider DC 125
0518 0960 000
C3/7-01



Kabelkanalschere DX-110
0518 0918 000
D4/6-01



Lamellen- und Nutschere DK-55
0518 0956 000
D4/6-01



Lamellen- und Nutschere DK-60
0518 0920 000
D4/6-01